

PM12 & PM16

PERFORMANCE MIXING CONSOLES INSTALLATION AND OPERATION MANUAL

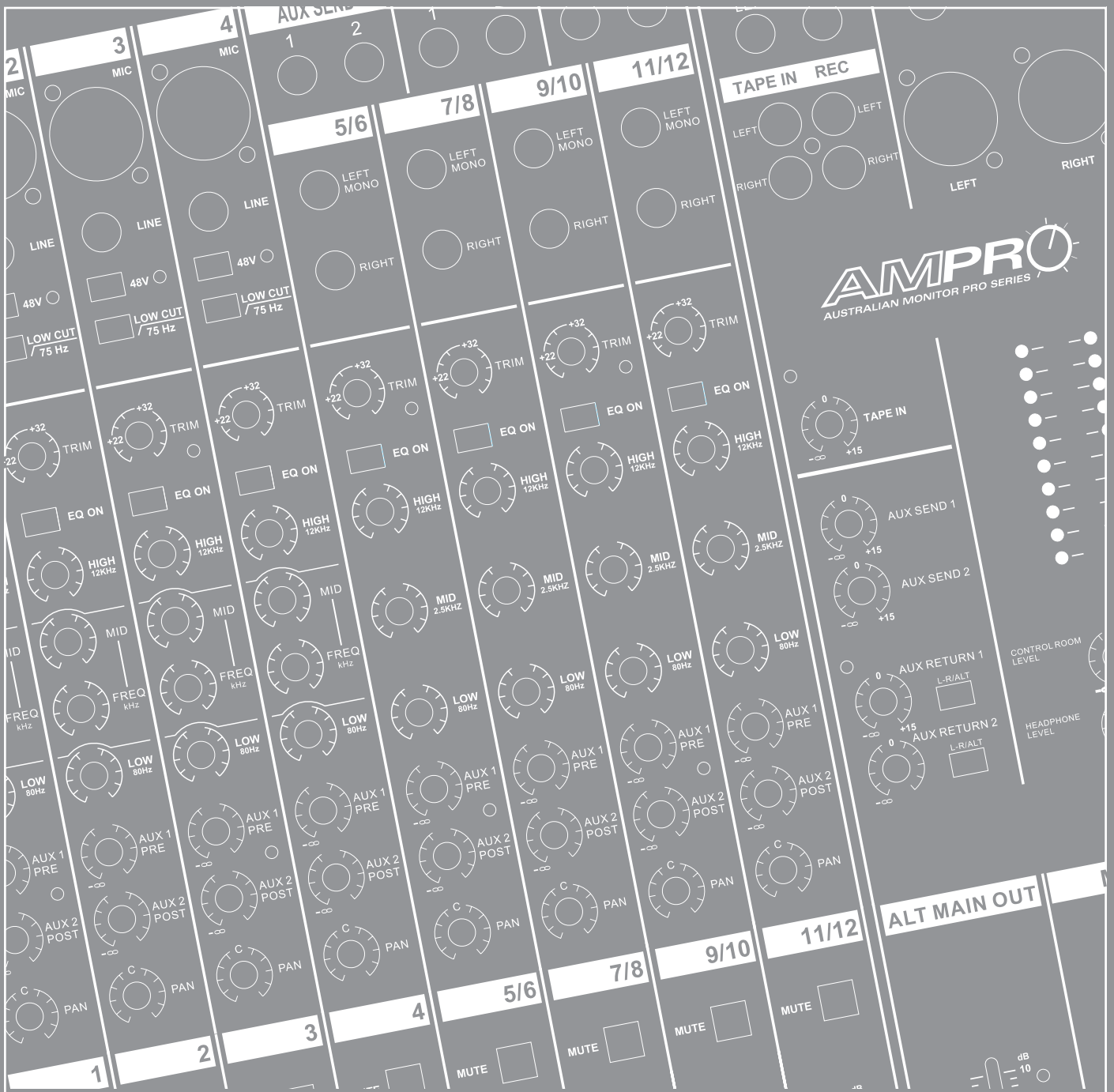



IMPORTANT SAFETY INFORMATION



1. Save the carton and packing material even if the equipment has arrived in good condition. Should you ever need to ship the unit, use only the original factory packing.
2. Read all documentation before operating your equipment. Retain all documentation for future reference.
3. Follow all instructions printed on unit chassis for proper operation.
4. Do not spill water or other liquids into or on the unit, or operate the unit while standing in liquid.
5. Make sure power outlets conform to the power requirements listed on the back of the unit.
6. Do not use the unit if the electrical power cord is frayed or broken. The power supply cords should be routed so that they are not likely to be walked on or pinched by items placed upon or against them, paying particular attention to cords and plugs, convenience receptacles, and the point where they exit from the appliance.
7. Always operate the unit with the AC ground wire connected to the electrical system ground. Precautions should be taken so that the means of grounding of a piece of equipment is not defeated.
8. Mains voltage must be correct and the same as that printed on the rear of the unit. Damage caused by connection to improper AC voltage is not covered by any warranty.
9. Have gain controls on amplifiers turned down during power-up to prevent speaker damage if there are high signal levels at the inputs.
10. Power down and disconnect units from mains voltage before making connections.
11. Never hold a power switch in the "ON" position if it won't stay there itself!
12. Do not use the unit near stoves, heat registers, radiators, or other heat producing devices.
13. Do not block fan intake or exhaust ports. Do not operate equipment on a surface or in an environment which may impede the normal flow of air around the unit, such as a bed, rug, weathersheet, carpet, or completely enclosed rack. If the unit is used in an extremely dusty or smoky environment, the unit should be periodically "blown free" of foreign matter.
14. Do not remove the cover. Removing the cover will expose you to potentially dangerous voltages. There are no user serviceable parts inside.
15. Do not drive the inputs with a signal level greater than that required to drive equipment to full output.
16. Do not connect the inputs / outputs of amplifiers or consoles to any other voltage source, such as a battery, mains source, or power supply, regardless of whether the amplifier or console is turned on or off.
17. Do not run the output of any amplifier channel back into another channel's input. Do not parallel- or series-connect an amplifier output with any other amplifier output. Australian Monitor Inc is not responsible for damage to loudspeakers for any reason.
18. Do not ground any red ("hot") terminal. Never connect a "hot" (red) output to ground or to another "hot" (red) output!
19. Non-use periods. The power cord of equipment should be unplugged from the outlet when left unused for a long period of time.
20. Service Information Equipment should be serviced by qualified service personnel when:
 - A. The power supply cord or the plug has been damaged.
 - B. Objects have fallen, or liquid has been spilled into the equipment.
 - C. The equipment has been exposed to rain.
 - D. The equipment does not appear to operate normally, or exhibits a marked change in performance.
 - E. The equipment has been dropped, or the enclosure damaged.

THIS SAFETY INFORMATION IS OF A GENERAL NATURE AND MAY BE SUPERSEDED BY INSTRUCTIONS CONTAINED WITHIN THIS MANUAL

INTRODUCTION AND CONTENTS

Ultra low noise 12 & 16 Channel Mic/Line Mixers

- 4 or 8 Mono Input Channels with silver plated XLRs and balanced Line Inputs
- 4 Stereo Input Channels with balanced TRS Jacks
- Ultra-low noise, discrete Mic Preamps with +48 V Phantom Power
- Balanced mic inputs for highest signal integrity
- Ultra-musical 3-band EQ with mid sweep on all mono channels, and 3-band EQ on all stereo channels
- 4 signal presence LEDs on all mono and stereo Channels
- 2 Aux Sends per channel for external effects and monitoring
- Separate master output, ALT MAIN outputs, control room output and headphone outputs
- Highly accurate 2x10 segment Bargraph Meters
- Rugged design power supply ensures superior signal integrity

INTRODUCTION	3
USER GUIDE OVERVIEW	4
MONO INPUT CHANNEL SECTION	5-6
STEREO CHANNEL SECTION	7-8
MASTER SECTION	9-10
MIXER OUTPUT SECTION	11
POWER SECTION	11
INSTALLATION	12
SPECIFICATIONS	13-14

AUS, EUR, USA
Copyright
Rev A:



CAUTION
RISK OF ELECTRIC SHOCK
DO NOT OPEN

CAUTION: TO REDUCE THE RISK OF ELECTRIC SHOCK,
DO NOT REMOVE COVER (OR BACK),
NO USER SERVICEABLE PARTS INSIDE,
REFER SERVICING TO QUALIFIED SERVICE PERSONAL.

WARNING!
TO REDUCE THE RISK OF FIRE OR ELECTRIC SHOCK
DO NOT EXPOSE THIS EQUIPMENT TO RAIN OR MOISTURE.



This symbol is intended to alert the user to the presence of uninsulated "dangerous voltage" within the products enclosure that may be of sufficient magnitude to constitute a risk of electric shock to persons.



This symbol is intended to alert the user to the presence of important operational and maintenance (servicing) instructions in the literature accompanying the appliance.

Caution: To prevent electric shock do not use this (polarised) plug with an extension cord, receptacle or other outlet unless the blades can be fully inserted to prevent blade exposure. To prevent electric shock, match wide blade of plug to wide slot, fully insert.

USER GUIDE OVERVIEW

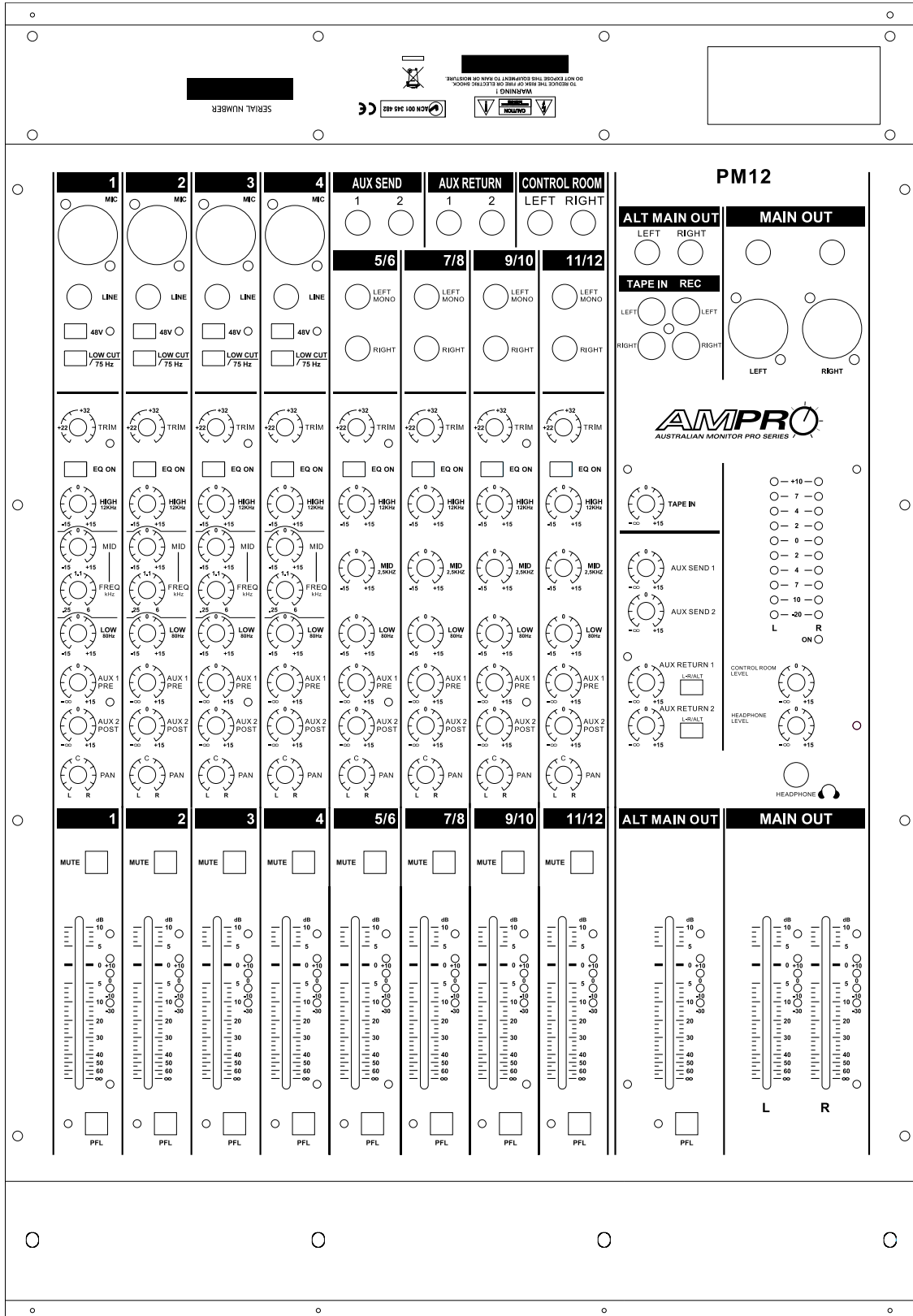

MONO INPUT CHANNEL SECTION

1 BALANCE INPUT (MIC)

Electronically balanced inputs accept a standard XLR male connector. + 48V Phantom power available on each input mic socket.

2 LINE INPUT

Accepts an unbalanced high impedance input signal. (Use for connecting deck, turntable, keyboard etc..)

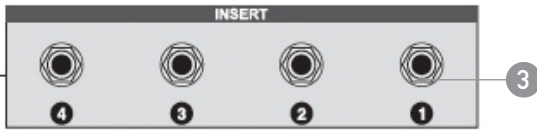

3 INSERT

Allows signal to be taken out from the mixer, routed through external equipment such as a compressor, and then back to the mixer to continue the final mix path.

4 PHANTOM POWER SWITCH

Depressing this switch on each channel applies 48V DC across the microphone input XLR connector for remote powering of condenser microphones. The LED will be turned on to indicate phantom power is enabled.

! IMPORTANT: ONLY turn the +48V phantom power switch on or off with all output faders DOWN, to prevent damage to the mixer or external devices.

5 LOW CUT

Depressing this switch inserts an 18 dB per octave, 75Hz low cut filter in the signal path. This is useful on live vocals to reduce stage rumble or "popping" from microphones. It can also be used to cut low frequency hum.

6 TRIM

Adjusts the input sensitivity of each channel.

7 EQ ON

Enables or disables the EQ. When the switch is depressed, the EQ is enabled. When the switch is in the "out" position, the EQ is disabled.

8 HIGH

Controls the high frequency response of each channel. Provides ± 15 dB at 12kHz.

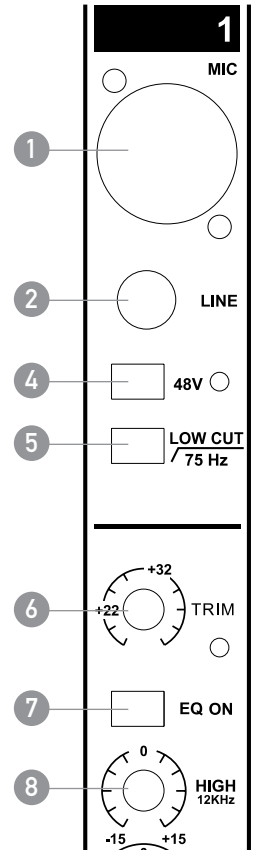

MONO INPUT CHANNEL SECTION

9 FREQUENCY + MID

Mid frequency adjustment. A 'bell response' adjustment that allows you to select the mid frequency, variable between 250Hz and 6kHz and to then vary the response ± 15 dB on either side of the selected frequency, with a fixed Q of 1.5Q (bandwidth).

10 LOW

Controls the low frequency response of each channel. Provides ± 15 dB at 80Hz.

11 AUX 1

This send is taken after the EQ section and pre fader (PRE-FADER, POST-EQ), and is therefore unaffected by the fader position. This is particularly suitable for foldback or monitor feeds, which need to be controlled separately from the main PA Mix.

12 AUX 2

This send is derived after the EQ and post fader (POST FADER, POST EQ), and therefore follows any changes in fader level. This send is normally used to drive effects processing units which are fed back into the mixer and which must track the channel fader.

13 PAN

Post fader and routes signal proportionally to the left and right outputs.

14 MUTE

Press to mute the channel.

15 CHANNEL FADER

Adjusts the level of the signal for the main left/right mix. Normal operating position is at the "0" mark.

16 SIGNAL PRESENCE METER

4 LEDs indicate signal level at the insert return point, pre-fader.

17 PFL

Monitor the channel with the PFL button. When the PFL switch is depressed, the adjacent LED will illuminate indicating PFL is active. The signal is routed to both the main signal presence meters and the headphone output, allowing both visual and audible monitoring of the signal.

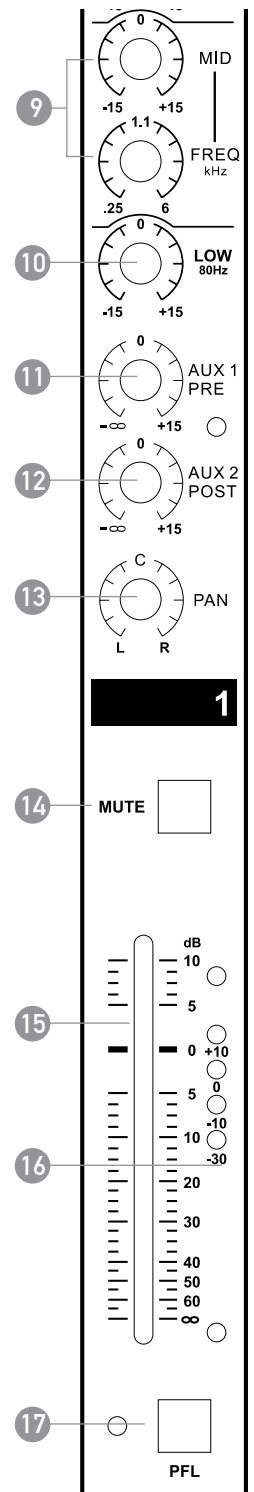

STEREO CHANNEL SECTION

18 LEFT (MONO) / RIGHT

1/4 jack input connectors. This input is half-normalised, allowing a mono signal connected to the left input to be present on both left and right output busses.

19 TRIM

Adjusts the input sensitivity of each channel.

20 EQ ON

Enables or disables the EQ. When the switch is depressed, the EQ is enabled. When the switch is in the "out" position, the EQ is disabled.

21 HIGH

Controls the high frequency response of each channel. Provides ± 15 dB at 12kHz.

22 MID

Controls the mid frequency response of each channel. Provides ± 15 dB at 2.5kHz.

23 LOW

Controls the low frequency response of each channel. Provides ± 15 dB at 80Hz.

24 AUX 1

This send is taken after the EQ section and pre fader (PRE-FADER, POST-EQ), and is therefore unaffected by the fader position. This is particularly suitable for foldback or monitor feeds, which need to be controlled separately from the main PA Mix. The Aux feed is a mono sum of both left and right audio signals.

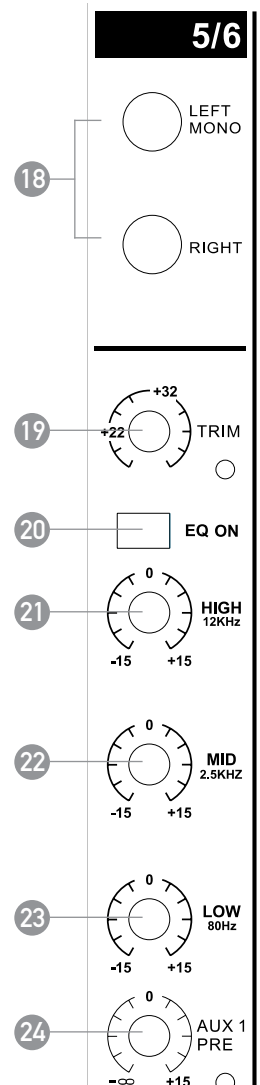

STEREO CHANNEL SECTION

25 AUX 2

This is derived after the EQ and channel fader (POST FADER, POST EQ), and follows any changes in fader level. Normally used to drive effects processing units which are fed back into the mixer and which must track the channel fader. The AUX feed is a mono sum of both left and right audio signals.

26 PAN

Post fader and routes signal proportionally to the left and right outputs.

27 MUTE

Press to mute the channel.

28 CHANNEL FADER

Adjusts the level of the signal for the main left/right mix. Normal operating position is at the "0" mark.

29 SIGNAL PRESENCE METER

4 LEDs indicate a signal level at the insert return point, pre-fader.

30 PFL

Monitor the channel with the PFL button. When the PFL switch is depressed, the adjacent LED will illuminate indicating PFL is active. The signal is routed to both the main signal presence meters and the headphone output, allowing both visual and audible monitoring of the signal.

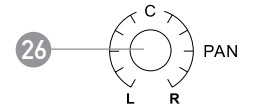
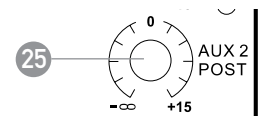

5/6

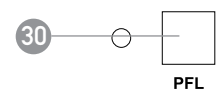
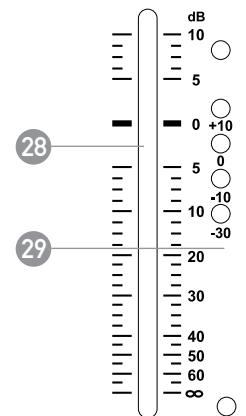

MASTER SECTION

31 TAPE IN

Adjusts the level of the TAPE IN signal to the main mix.

32 AUX SENDS 1-2

Adjusts the master output level for AUX 1 and AUX 2.

33 AUX RETURN 1-2

Controls the level of the AUX return input into the main mix.

34 L-R / ALT

In the up position, the return input signal is routed to the Main L-R; In the down position, the return input signal is routed to the ALT Main Out.

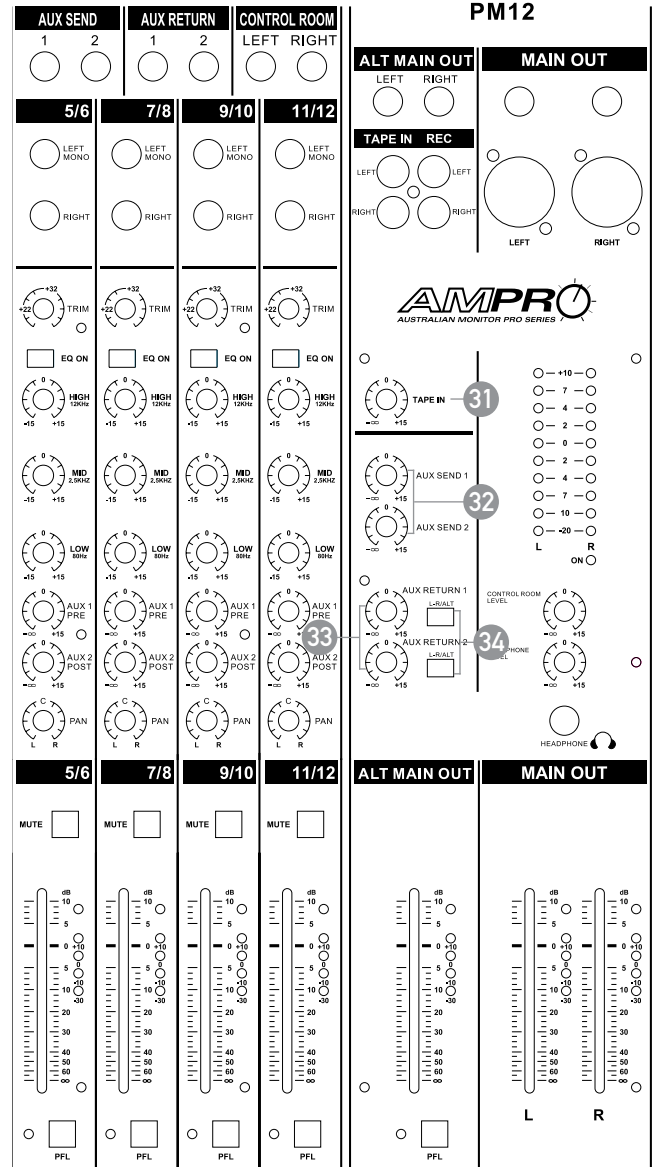

MASTER SECTION

35 MAIN LEVEL INDICATOR

Displays the output levels of the left and right mix.

36 POWER LED

The POWER LED is illuminated when AC power is available and the mixer is turned on.

37 CONTROL ROOM LEVEL

Controls the level to the CONTROL ROOM monitors.

38 HEADPHONE LEVEL

Controls the level of the headphone output.

39 PHONE JACK

Stereo jack for monitoring each channel via PFL or L/R busses signal.

40 ALT MAIN OUT FADER

Adjusts the ALT MAIN output level.

41 PFL

Monitor the channel with the PFL button. When the PFL switch is depressed, the adjacent LED will illuminate indicating PFL is active. The signal is routed to both the main signal presence meters and the headphone output, allowing both visual and audible monitoring of the signal.

42 MAIN FADER (LEFT/RIGHT)

Adjustment of the main left/right output levels.

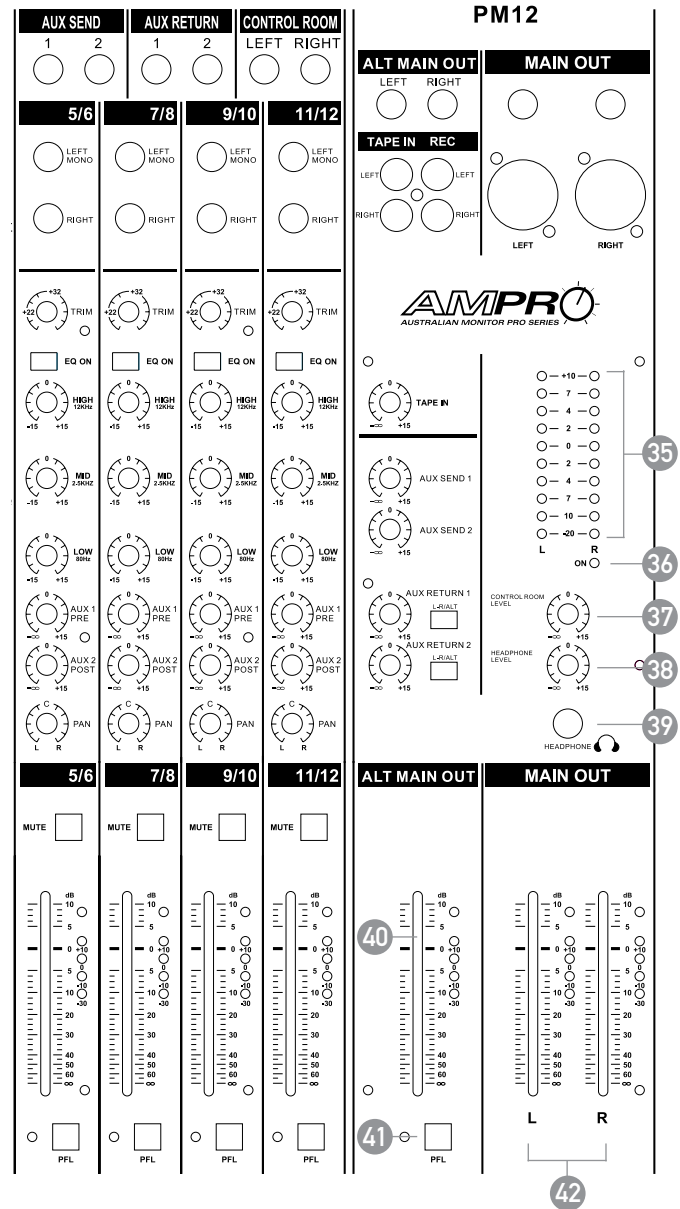

MIXER OUTPUT SECTION

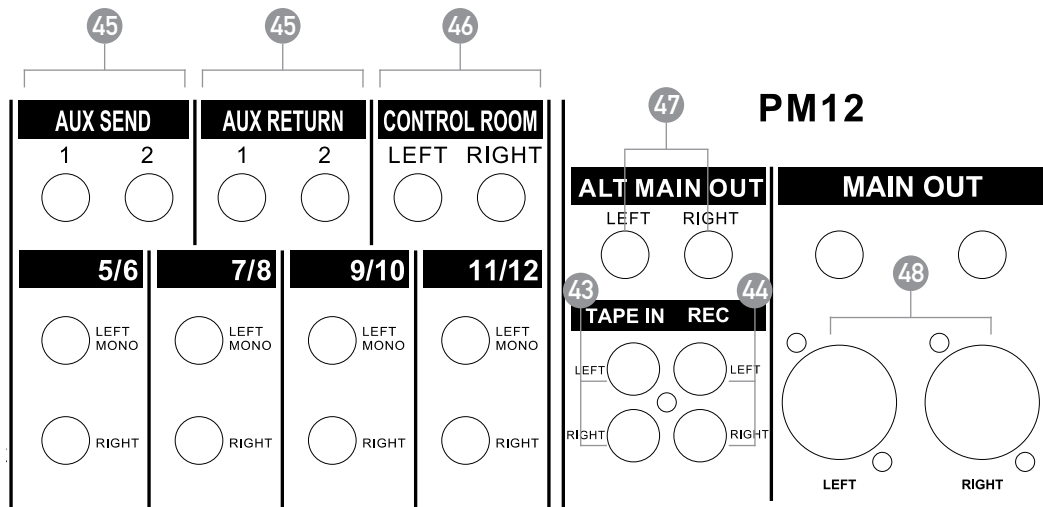

43 TAPE INPUT

This stereo RCA input can be connected to a cassette, deck, ipod, etc.

44 RECORD

This stereo RCA output can be connected to a recording device for recording the main mix output.

45 AUX RETURNS & SENDS

Connects all kinds of external foldback, FX and processing equipment.

46 CONTROL ROOM

This is an alternate output, with the same signal as the headphone output.

47 ALT MAIN OUTPUT

Outputs the same mix as main output. Level of this output is adjusted by the "ALT MAIN OUT" fader.

48 MAIN OUTPUT (LEFT / RIGHT)

Main stereo output mix. Available on both balanced XLR at 1/4" jack connectors.

POWER SECTION

49 POWER SWITCH

Master power switch. When in the 'on' position and power is available, LED (see 38) will illuminate.

50 POWER CONNECTOR

Connector for the supplied external power supply. Use only supplied power supply.

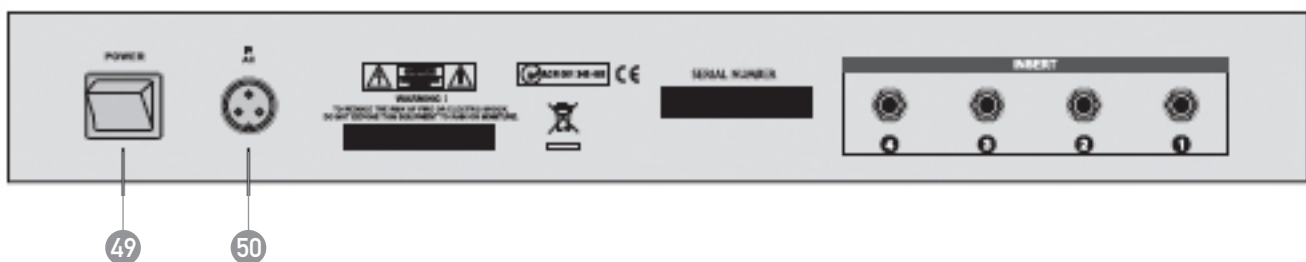

INSTALLATION

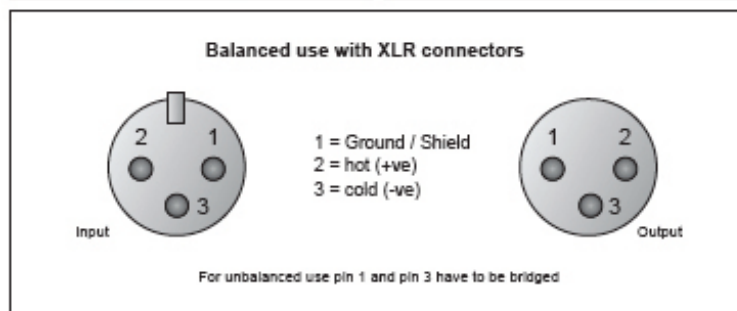
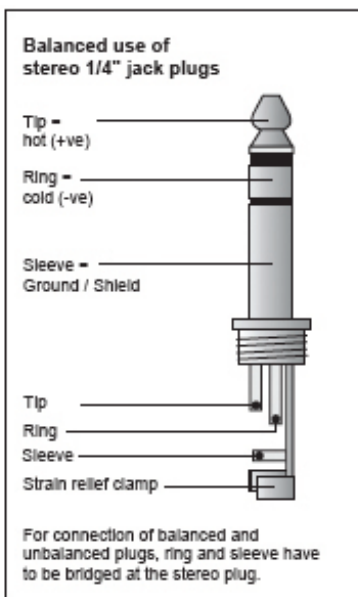
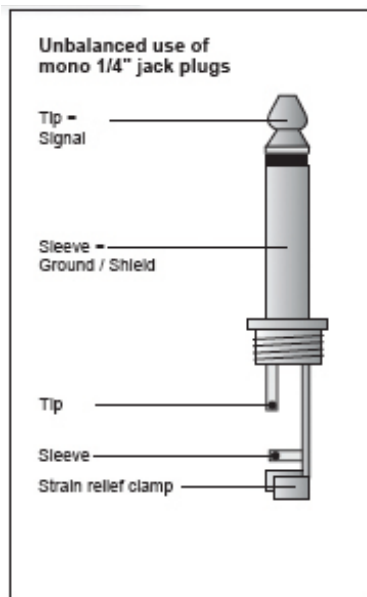
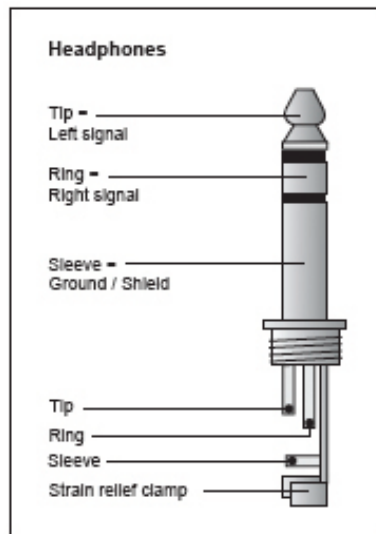

SPECIFICATIONS

MONO INPUTS

MIC INPUT		Electronically balanced, discrete input configuration
DISTORTION (THD & N)		0.1% at +4 dBu, 1 kHz, Bandwidth 80 kHz
MIC E.I.N (22 HZ - 22 KHZ)		-129.5 dBu, 150 Ohm source -117.3 dBqp, 150 Ohm source -132.0 dBu, input shorted -122.0 dBqp, input shorted
TRIM RANGE	MIC LINE	+41dB Variable (-50dB, -9dB) +41dB Variable (-30dB, +11dB)
LINE INPUT		Electronically balanced
BANDWIDTH		10 Hz to 60 kHz \pm 3 dB
LINE LEVEL RANGE		+11 dBu to -30 dBu
EQUALIZATION	HI SHELVING MID BELL LO SHELVING LO CUT (HIGH PASS) FILTER	12 kHz +/-15 dB 250Hz -6KHz +/- 15dB, Q fixed at 1 oct 80 Hz +/-15 dB -3dB at 75Hz, 18dB / oct

STEREO INPUTS

LINE INPUT		Unbalanced
BANDWIDTH		10 Hz to 55 kHz \pm 3 dB
DISTORTION (THD & N)		0.01% at +4 dBu, 1 kHz, bandwidth 80 kHz

SPECIFICATIONS

MASTER MIX SECTION

FREQUENCY RESPONSE	20Hz ~ 20kHz. +1/-2dB
MAX OUTPUT	+20 dBu balanced
AUX SEND MAX OUT	+20 dBu unbalanced
CONTROL ROOM OUT	+20 dBu unbalanced
SIGNAL-TO-NOISE RATIO	90 dBu, all channels at Unity Gain
CROSSTALK (AT 1 KHZ)	-70 dB between input channels; -70dB between input/output channels

POWER SUPPLY

MAINS VOLTAGES	USA/Canada	~ 115 V AC, 60 Hz
	U.K./Europe	~ 230 V AC, 50 Hz
	Australia/NZ	~ 230 V AC, 50 Hz

	PM12	PM16
SIZE (w x h x d)	335 x 88 x 435mm 13.2" x 3.5" x 17.2"	445 x 88 x 435mm 17.6" x 3.5" x 17.2"
NET WEIGHT	8.5kg 18.7lb	11.0kg 24.2lb
SHIPPING DIMENSIONS (w x h x d)	525 x 175 x 385mm 20.7" x 6.9" x 15.2"	525 x 175 x 385mm 20.7" x 6.9" x 15.2"
SHIPPING WEIGHT	10.5kg 23.1lb	13.0kg 28.6lb

AUSTRALIA AND NEW ZEALAND

www.australianmonitor.com.au

SYDNEY

(NSW & ACT SALES)

1 Clyde Street
Silverwater
NSW 2128
Private Bag 149
Silverwater NSW 1811
Phone: (02) 9647 1411
Fax: (02) 9648 3698
Email:
nsw@audiotelex.com.au

MELBOURNE

(VIC & TAS SALES)

22/277
Middleborough Road
Box Hill VIC 3128
PO Box 151 Blackburn
South VIC 3130
Phone: (03) 9890 7477
Fax: (03) 9890 7977
Email:
vic@audiotelex.com.au

BRISBANE

(QLD SALES)

42 Commercial Road
Fortitude Valley
QLD 4006
PO Box 2578 Fortitude
Valley BC QLD 4006
Phone: (07) 3852 1312
Fax: (07) 3252 1237
Email:
qld@audiotelex.com.au

ADELAIDE

(SA & NT SALES)

31 Walsh Street
Thebarton
SA 5031
PO Box 157
Hindmarsh SA 5007
Phone: (08) 8352 4444
Fax: (08) 8352 4488
Email:
sa@audiotelex.com.au

PERTH

(WA SALES)

3/11 Howe Street
Osborne Park WA 6017
PO Box 1281
Osborne Park BC
WA 6916
Phone: (08) 9204 0200
Fax: (08) 9244 3783
Email:
wa@audiotelex.com.au

AUCKLAND

(NZ SALES)

9C Piermark Drive
Albany 0752
New Zealand
PO Box 300-512
Albany 0752
Phone: (09) 415 9426
Fax: (09) 415 9864
Email:
sales@audiotelex.co.nz

EUROPE / ASIA / MIDDLE EAST

www.australianmonitor.com.au

INTERNATIONAL SALES

1 Clyde Street Silverwater NSW 2128 Australia
Private Bag 149 Silverwater NSW 1811
Phone: + 61 2 9647 1411
Fax: + 61 2 9748 2537
Email: international@audiotelex.com.au